

ECOSAFE-Safety Shower

ECO2010EXP

Zero Lead Stainless Steel 304 Ceiling Mounted Safety Shower

Nominal Flow: Nominal Flow: 75.7 lpm



Product Features



- Signs & Test Tags included with product
- Temperature relief valves available for temperatures outside of 16°C - 38°C
- Cyclonic shower head design has a spray pattern with a minimum diameter of 50.8cm for complete coverage
- Water distribution pattern in shower head and the flow holes are designed to prevent any lime build up or restrictions
- Recommended for Science, Education and Industrial projects
- Audio & Visual Alarms Available with Connection to BMS Systems

Technical Information



Materials	Zero Lead Stainless Steel 304
Cartridge	Ball Valve
Cartridge Size	25mm
Inlet	25mm Male
Flow Style	Cyclonic
Working Pressures	210kPa-500kPa
Recommended Working Pressures	350kPa
Working Temperatures	16°C - 38°C
Finish / Colour	Polished
Warranty	2 Years (Base Warranty)

Product Certifications



AS 4775:2007
License No. AMI 74767



A: Unit 6, 20 - 28 Ricketty St, Mascot, NSW 2020
P: +612 9319 4422
F: +612 8088 7635
E: info@gentecaustralia.com.au



Gentec products come with a Manufacturer's Warranty. To ensure the validity of this warranty, Gentec products must be installed following the provided installation instructions and adhering to AS 3500, NCC Volume Three, relevant Australian Standards, and any local authority requirements applicable to the product. Additionally, water and electrical supply conditions must meet the appropriate national and/or state standards. Non-compliance with these provisions may impact product performance and void the warranty.

Technical Drawings



All measurements are in millimetres and should be used as a guide only.

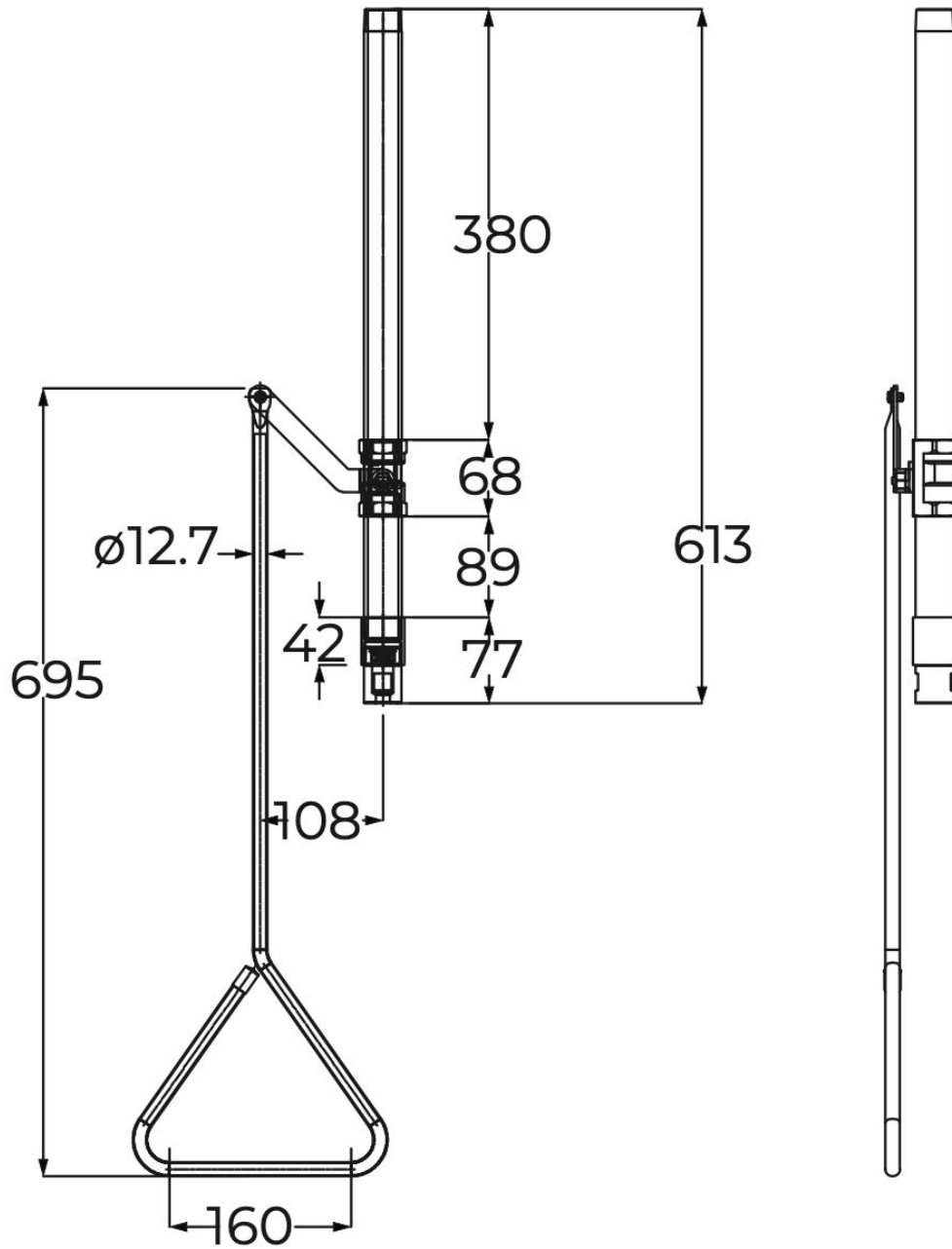

Disclaimer: Stainless Steel Grades 304 & 316 are manufactured with ZERO* Lead.



A: Unit 6, 20 - 28 Ricketty St, Mascot, NSW 2020
P: +612 9319 4422
F: +612 8088 7635
E: info@gentecaustralia.com.au



Note: The information provided is only a guide, actual product may differ. The information here should not be relied on without clarification with Gentec. Gentec reserves the right to make design changes at any time without notification.

Subject to terms and conditions. For detailed warranty information, installation compliance, maintenance and cleaning guidelines, and other relevant details, please visit <https://gentecaustralia.com.au>