

CLEANLINE-Recess Mixing Set

CL10035-4

DZR Brass In-Wall 100mm Lever Recess Mixing Set w/ Gooseneck Swivel Spout

6 Star 4.5 lpm
(Nominal Flow : 3.1 lpm)



Product Features



- No crevices to eliminate bacterial build-up
- Handles with Red, Yellow & Blue button indicators supplied
- Soft seal, easy action ceramic disk cartridge
- Allen key fixings for secure handles and outlets
- Interchangeable Handles (100mm Lever, 150mm Lever and Capstan)
- Three cartridges used in all Cleanline products for easier maintenance
- Laminar flow available
- Product customisation available
- Recommended for use in health and aged care projects
- CL10035 has 4 Star 7.5 lpm

Technical Information



Materials	DZR Brass
Cartridge	Ceramic Disc (Quarter Turn)
Cartridge Size	15mm
Inlet	15mm
Flow Style	Laminar Flow
Working Pressures	50kPa-500kPa
Recommended Working Pressures	350kPa
Working Temperatures	5°C - 80°C
Finish / Colour	Chrome Plated
Warranty	2 Years (Base Warranty)

Product Certifications



WELS: T41106



A: Unit 6, 20 - 28 Ricketty St, Mascot, NSW 2020
P: +612 9319 4422
F: +612 8088 7635
E: info@gentecaustralia.com.au



Gentec products come with a Manufacturer's Warranty. To ensure the validity of this warranty, Gentec products must be installed following the provided installation instructions and adhering to AS 3500, NCC Volume Three, relevant Australian Standards, and any local authority requirements applicable to the product. Additionally, water and electrical supply conditions must meet the appropriate national and/or state standards. Non-compliance with these provisions may impact product performance and void the warranty.

Technical Drawings



All measurements are in millimetres and should be used as a guide only.

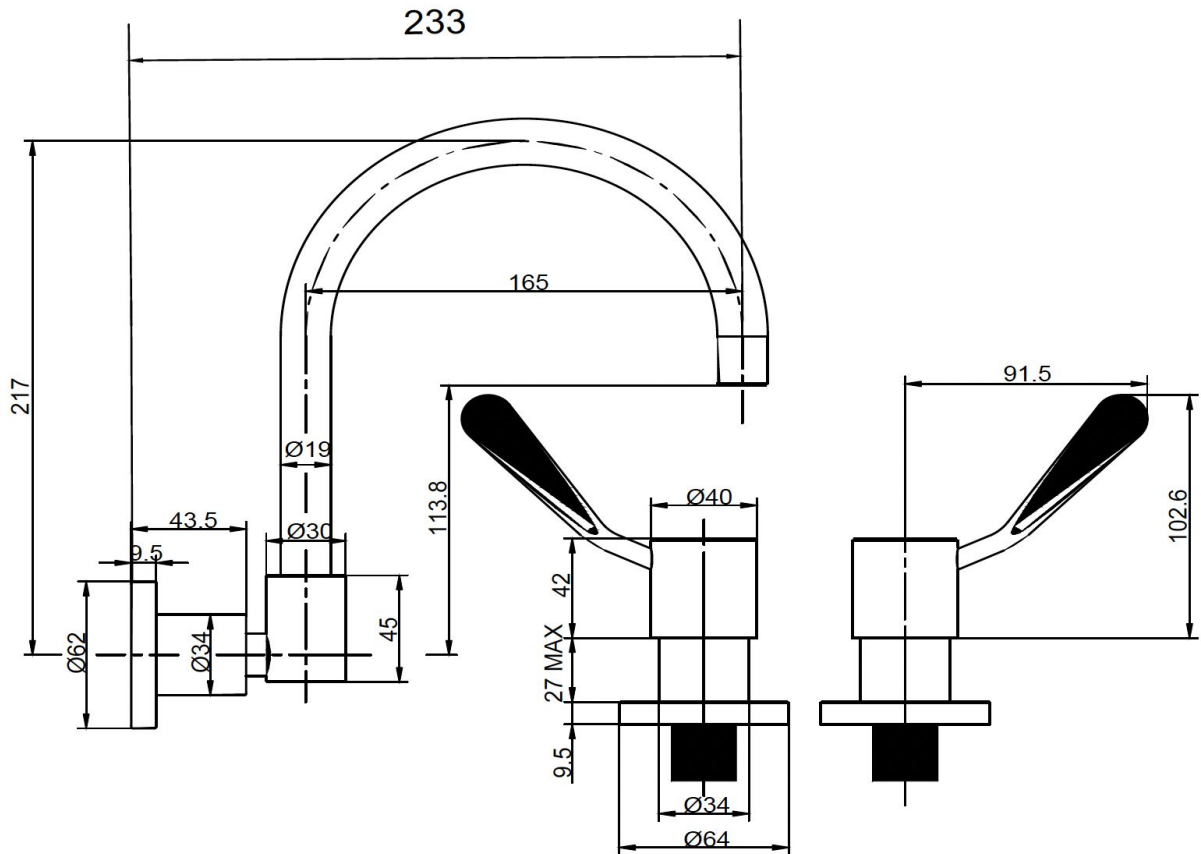

Disclaimer: Stainless Steel Grades 304 & 316 are manufactured with ZERO* Lead.



A: Unit 6, 20 - 28 Ricketty St, Mascot, NSW 2020
P: +612 9319 4422
F: +612 8088 7635
E: info@gentecaustralia.com.au



Note: The information provided is only a guide, actual product may differ. The information here should not be relied on without clarification with Gentec. Gentec reserves the right to make design changes at any time without notification.

Subject to terms and conditions. For detailed warranty information, installation compliance, maintenance and cleaning guidelines, and other relevant details, please visit <https://gentecaustralia.com.au>